

Article number: 203180M24174B4W

Description: E+G levelling foot
GN 31-80-M24-174-B4-W

Note: W With adjustable sleeve , Hygienic Version, Wrench flat at the bottom

Measures

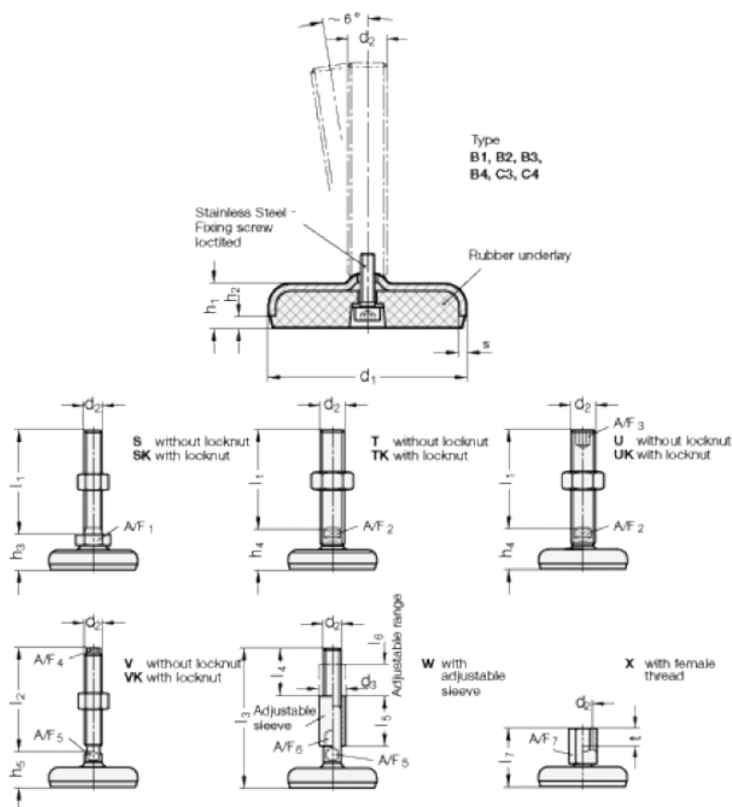

A/F5 = 20	l3 +4.0/0 = 174
A/F6 = 30	l4 = 67
d1 = 80	l5 = 67
d2 = 24	l6 = 42
d3 = 35	s = 3
h1 = 18	
h2 = 5	
l1 = 174	